

Panasonic®

Video Monitor Operating Instructions WV-LD1500 WV-LD2000

Model Nos.

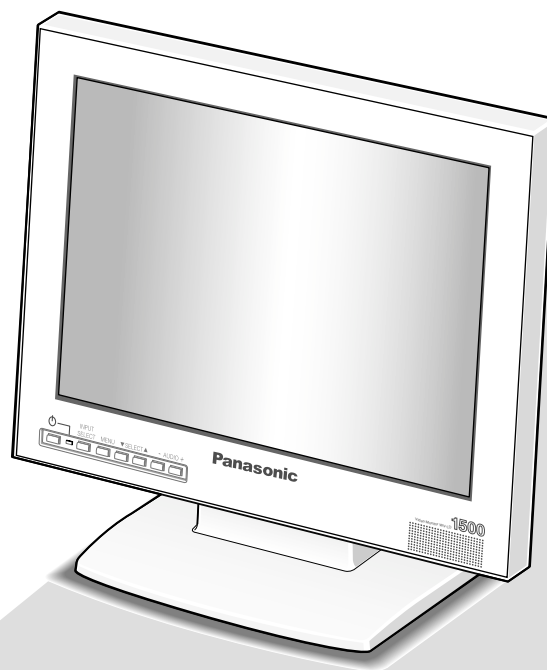



ENGLISH

FRANÇAIS

Before attempting to connect or operate this product,
please read these instructions carefully and save this manual for future use.

ENGLISH VERSION

	CAUTION RISK OF ELECTRIC SHOCK DO NOT OPEN	
<p>CAUTION: TO REDUCE THE RISK OF ELECTRIC SHOCK, DO NOT REMOVE COVER (OR BACK). NO USER-SERVICEABLE PARTS INSIDE. REFER SERVICING TO QUALIFIED SERVICE PERSONNEL.</p>		

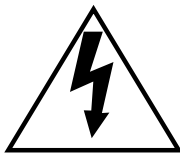

SA 1965

The lightning flash with arrowhead symbol, within an equilateral triangle, is intended to alert the user to the presence of uninsulated "dangerous voltage" within the product's enclosure that may be of sufficient magnitude to constitute a risk of electric shock to persons.



SA 1966

The exclamation point within an equilateral triangle is intended to alert the user to the presence of important operating and maintenance (servicing) instructions in the literature accompanying the appliance.



Power disconnection. Unit with or without ON-OFF switches have power supplied to the unit whenever the power cord is inserted into the power source; however, the unit is operational only when the ON-OFF switch is in the ON position. The power cord is the main power disconnect for all units.

— For Canada —

This Class A digital apparatus complies with Canadian ICES-003.

— For U.S.A. —

NOTE: This equipment has been tested and found to comply with the limits for a Class A digital device, pursuant to Part 15 of the FCC Rules. These limits are designed to provide reasonable protection against harmful interference when the equipment is operated in a commercial environment. This equipment generates, uses, and can radiate radio frequency energy and, if not installed and used in accordance with the instruction manual, may cause harmful interference to radio communications.

Operation of this equipment in a residential area is likely to cause harmful interference in which case the user will be required to correct the interference at his own expense.

FCC Caution: To assure continued compliance, (example - use only shielded interface cables when connecting to computer or peripheral devices). Any changes or modifications not expressly approved by the party responsible for compliance could void the user's authority to operate this equipment.

The serial number of this product may be found on the surface of the unit.

You should note the serial number of this unit in the space provided and retain this book as a permanent record of your purchase to aid identification in the event of theft.

Model No. _____

Serial No. _____

WARNING:

- This apparatus must be earthed.
- To prevent fire or electric shock hazard, do not expose this apparatus to rain or moisture.
- The apparatus should not be exposed to dripping or splashing and that no objects filled with liquids, such as vases, should be placed on the apparatus.
- All work related to the installation of this product should be made by qualified service personnel or system installers.

IMPORTANT SAFETY INSTRUCTIONS

- 1) Read these instructions.
- 2) Keep these instructions.
- 3) Heed all warnings.
- 4) Follow all instructions.
- 5) Do not use this apparatus near water.
- 6) Clean only with dry cloth.
- 7) Do not block any ventilation openings. Install in accordance with the manufacturer's instructions.
- 8) Do not install near any heat sources such as radiators, heat registers, stoves, or other apparatus (including amplifiers) that produce heat.
- 9) Do not defeat the safety purpose of the polarized or grounding-type plug. A polarized plug has two blades with one wider than the other. A grounding type plug has two blades and a third grounding prong. The wide blade or the third prong are provided for your safety. If the provided plug does not fit into your outlet, consult an electrician for replacement of the obsolete outlet.
- 10) Protect the power cord from being walked on or pinched particularly at plugs, convenience receptacles, and the point where they exit from the apparatus.
- 11) Only use attachments/accessories specified by the manufacturer.
- 12) Use only with the cart, stand, tripod, bracket, or table specified by the manufacturer, or sold with the apparatus. When a cart is used, use caution when moving the cart/apparatus combination to avoid injury from tip-over.



- 13) Unplug this apparatus during lightning storms or when unused for long periods of time.
- 14) Refer all servicing to qualified service personnel. Servicing is required when the apparatus has been damaged in any way, such as power-supply cord or plug is damaged, liquid has been spilled or objects have fallen into the apparatus, the apparatus has been exposed to rain or moisture, does not operate normally, or has been dropped.

LIMITATION OF LIABILITY

THIS PUBLICATION IS PROVIDED "AS IS" WITHOUT WARRANTY OF ANY KIND, EITHER EXPRESS OR IMPLIED, INCLUDING BUT NOT LIMITED TO, THE IMPLIED WARRANTIES OF MERCHANTABILITY, FITNESS FOR ANY PARTICULAR PURPOSE, OR NON-INFRINGEMENT OF THE THIRD PARTY'S RIGHT.

THIS PUBLICATION COULD INCLUDE TECHNICAL INACCURACIES OR TYPOGRAPHICAL ERRORS. CHANGES ARE ADDED TO THE INFORMATION HEREIN, AT ANY TIME, FOR THE IMPROVEMENTS OF THIS PUBLICATION AND/OR THE CORRESPONDING PRODUCT (S).

DISCLAIMER OF WARRANTY

IN NO EVENT SHALL MATSUSHITA ELECTRIC INDUSTRIAL CO., LTD. BE LIABLE TO ANY PARTY OR ANY PERSON, EXCEPT FOR CERTAIN WARRANTY PROGRAM OFFERED BY THE LOCAL DEALER OF PANASONIC, FOR THE CASES INCLUDING BUT NOT LIMITED TO BELOW:

- (1) ANY DAMAGE AND LOSS, INCLUDING WITHOUT LIMITATION, DIRECT OR INDIRECT, SPECIAL, CONSEQUENTIAL OR EXEMPLARY, ARISING OUT OF OR RELATING TO THE PRODUCT;
- (2) PERSONAL INJURY OR ANY DAMAGE CAUSED BY INAPPROPRIATE USE OR NEGLIGENT OPERATION OF THE USER;

- (3) UNAUTHORIZED DISASSEMBLE, REPAIR OR MODIFICATION OF THE PRODUCT BY THE USER.

CONTENTS

IMPORTANT SAFETY INSTRUCTIONS	3
LIMITATION OF LIABILITY	4
DISCLAIMER OF WARRANTY	4
PRECAUTIONS	6
PREFACE	7
FEATURES	7
MAJOR OPERATING INSTRUCTIONS AND THEIR FUNCTIONS	8
■ Front View	8
■ Rear View	8
INSTALLATIONS	10
■ Removing the Monitor Stand	10
■ Mounting on the Wall	10
CONNECTIONS	11
■ Connection Example	11
■ Camera Connection	12
■ Connection with Two or More Video Monitors	12
■ Digital Disk Recorder Connection	12
■ PC Connection	12
POWER-ON	13
AUDIO VOLUME CONTROL	14
VIDEO ADJUSTMENT AND SETUP	14
■ VIDEO ADJUST Menu	14
■ Setting of PC Input	15
■ Language Setup	17
TROUBLESHOOTING	18
SPECIFICATIONS	19
■ Video Monitor	19
■ AC Adapter	20
STANDARD ACCESSORIES	20

PRECAUTIONS

- **Refer all work related to the installation of this apparatus to qualified service personnel or system installers.**
 - **Do not block the ventilation opening or slots on the cover.**

To prevent the apparatus from overheating, place it at least 5 cm {2 inches} away from the wall.
 - **Do not drop metallic parts through slots.**

This could permanently damage the apparatus. Turn the power off immediately and contact qualified service personnel for service.
 - **Do not attempt to disassemble the apparatus.**

To prevent electric shock, do not remove screws or covers.
There are no user-serviceable parts inside. Contact qualified service personnel for maintenance.
 - **Do not strike or give a strong shock to the unit.**

It may cause damage or allow water to enter the unit.
 - **Do not expose the apparatus to water or moisture. Do not try to operate it in wet areas.**

Take immediate action if the apparatus gets wet. Turn the power off and refer servicing to qualified service personnel. Moisture can damage the apparatus and also cause electric shocks.
 - **Cleaning**

Turn the power off when cleaning the unit. Otherwise it may cause injuries.
Do not use strong or abrasive detergents when cleaning the apparatus body.
Use a dry cloth to clean the apparatus when it is dirty.
When the dirt is hard to remove, use a mild detergent and wipe gently.
 - **Do not operate the apparatus beyond its specified temperature, humidity, or power source ratings.**

Use the apparatus under conditions where temperatures are between 0 °C and + 40 °C {+32 °F to +104 °F}, and humidity below 90 %.
The input power source for this apparatus is 100 V to 240 V AC, 50/60 Hz.
- * Supplied AC power cord supports 120 V AC only. To use this product with larger power source, replace the power cord.
- **Do not mount the monitor on places subject to constant vibrations. That may cause trouble or damage.**
 - **Use only the supplied power cord or AC adapter.**
 - **The surface of the LCD Panel is applied by special coating.**

Do not point hard objects and wipe by abrasive material. It can cause scratches and damages on the LCD screen.
 - **The LCD panel is made from a very precise technology.**

Some bright and dark spots may exist on the monitor screen. It is operating normally if there are 99.99 % active pixels.
- **Clear a space of more than 5 cm {2 inches} from both sides, the top, the bottom and the rear of the units.**

PREFACE

Video Monitor WV-LD1500/2000 is 15"/20" LCD monitor, using a high-brightness liquid crystal panel and (3D)* separation circuit for improved definition of picture display.

*NTSC system only

FEATURES

- Built-in VGA panel with high brightness, high contrast ratio
- Supporting composite video signal, S-video signal, and analog RGB signal for personal computer (PC)
- Automatically switchable NTSC and PAL system
- PC display capacity supporting VGA (640x480) resolutions. Picture size and display position can be automatically adjusted.
- Audio input x1, audio output x1, and speaker output (max. 1.5 W) x 1
- On-screen setup menu
- Auto-volt power supply from 100 V AC to 240 V AC (with the supplied AC adapter.)
Note: Supplied AC power cord supports 120 V AC only. To use this product with larger power source, replace the power cord.
- Screw holes for VESA mounting at the rear comply with the industry standard specification of VESA (Video Electronics Standards Association). This product can be mounted on a wall by installing a locally procured mounting bracket.

MAJOR OPERATING INSTRUCTIONS AND THEIR FUNCTIONS

■ Front View

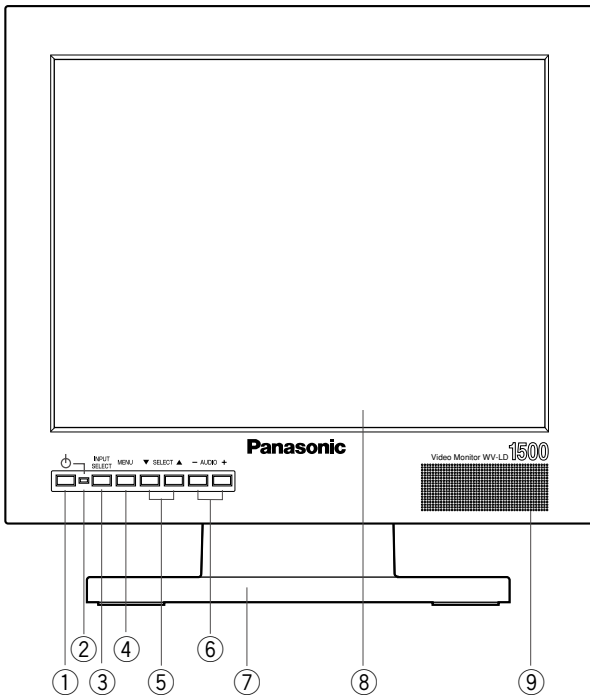

■ Rear View

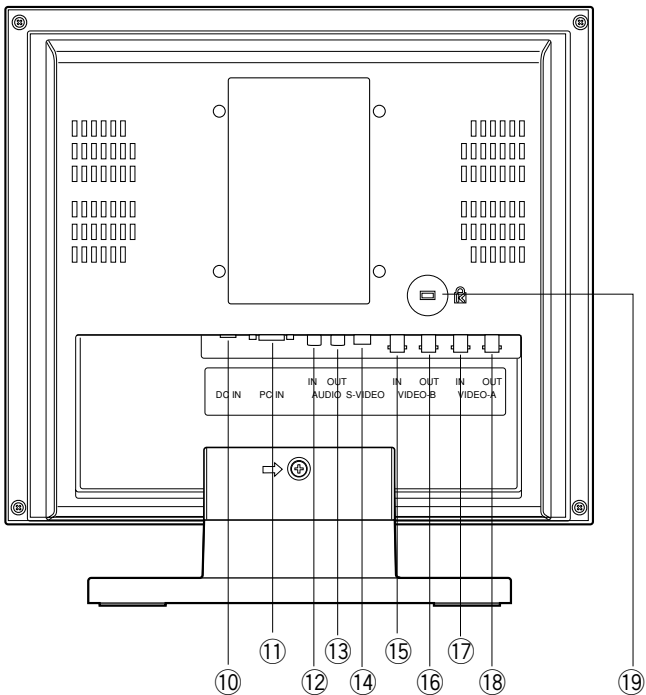

These are the illustrations of WV-LD1500.

① **Power Button**

Powers on or off the monitor.

Note: Power is supplied from the AC adapter even while the monitor is OFF.

② **Power Indicator**

This indicator is lighting while power is supplied to the monitor.

③ **Input Signal Selection Button (INPUT SELECT)**

Every pressing this button can change input signals as follows.

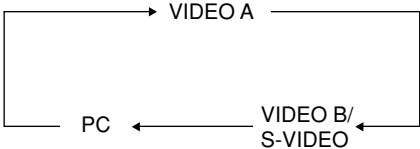

④ **Menu Button (MENU)**

- Displays the VIDEO ADJUST menu.
- Determines the selected parameter in setup menus.

⑤ **Selection Buttons (SELECT: ▼, ▲)**

These buttons move the cursor in setup menus.

⑥ **Audio Buttons (AUDIO: +, -)**

- These buttons adjust the audio volume level.
- These buttons increments or decrements the selected parameter in setup menus.

⑦ **Monitor Stand**

⑧ **Display Panel**

⑨ **Speaker**

⑩ **DC Input jack (DC IN)**

AC adapter, supplied with the monitor, is plugged into this jack.

⑪ **PC input connector (PC IN)**

Accepts an analog RGB signal from a PC.

Note: For timing data this connector supports, refer to p. 9 "Timing data chart for PC input".

⑫ **Audio input connector (AUDIO IN)**

With an audio cable connection, this connector accepts an audio signal from an external device and supplies the signal to the built-in speaker.

⑬ **Audio output connector (AUDIO OUT)**

Supplies an audio signal accepted by the AUDIO IN connector to another external device.

⑭ **S-video input connector (S-VIDEO IN)**

Accepts an S-video signal from an external device.

Note: This connector and the VIDEO-B IN connector is connected to the same device. When an S-video signal and composite video signal are supplied from a device at the same time, the S-video signal is accepted by priority.

⑮ **Video input B connector (VIDEO-B IN)**

Accepts a composite video signal from an external device.

⑯ **Video output B connector (VIDEO-B OUT)**

Supplies a composite video signal accepted by the VIDEO-B IN connector to another external device.

⑰ **Video input A connector (VIDEO-A IN)**

Accepts a composite video signal from an external device.

⑱ **Video output A connector (VIDEO-A OUT)**

Supplies a composite video signal accepted by the VIDEO-A IN connector to another external device.

⑲ **Security slot**

You can attach a lock that meets the industry standard specification (3 to 3.26 mm x 7 to 7.26 mm x 3.5 to 4 mm) {0.12" x 0.28" x 0.15"}.

Timing data chart for PC input

This monitor supports the timing data listed as follows.

Standard	Resolution	Dot clock frequency (MHz)	Horizontal frequency (kHz)	Vertical frequency (Hz)
Industry	640 x 480	25.17	31.46	59.93
VESA (Video Electronics Standards Association)	640 x 480	31.50	37.86	72.81
	640 x 480	31.50	37.50	75.00

Notes:

- If an input signal does not meet the standards (dot clock frequency, horizontal frequency, and vertical frequency), "OUT OF RANGE" will appear on the screen.



- This monitor does not support plug-and-play.

INSTALLATIONS

WARNING

The installations described in the figures should be made by qualified service personnel or system installers.

Caution: Attach this monitor to a flat wall with a locally procured mounting bracket. After the installation, secure the monitor to prevent dropping.

Places to be avoided

- Very dirty and dusty places
- Places subject to strong vibrations
- Humid places
- Places where drastic temperature changes occur
- Places which are not level
- Steamy and oily places such as kitchens

■ Removing the Monitor Stand

Before mounting the monitor on the wall, remove the monitor stand.

1. Remove the screw of stand cover (M4), and then remove the stand cover.
2. Remove the four screws of monitor stand, and then remove the monitor stand.

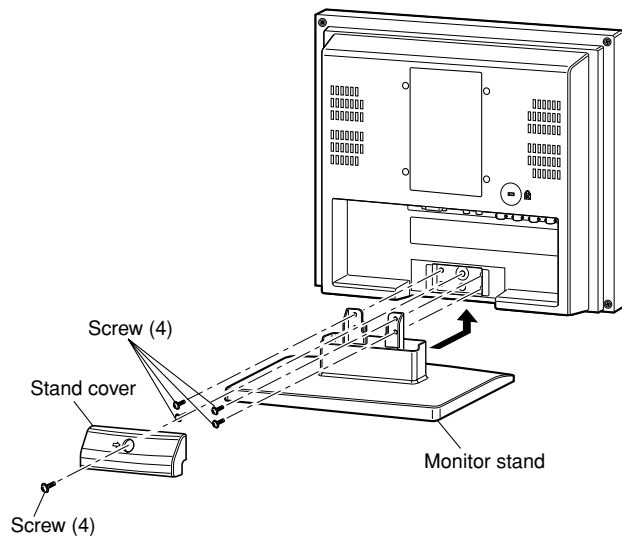

■ Mounting on the Wall

To mount the monitor on the wall, a mounting bracket (locally procured, VESA standard 100 mm {3-9/10"} pitch) and screw (M4, locally procured) are required.

Notes:

- Do not block the ventilation opening or slots on the cover.
- Do not mount the monitor on places subject to constant vibrations. That may cause trouble or damage.
- Do not install the AC adapter into the wall. That may cause temperature to rise.

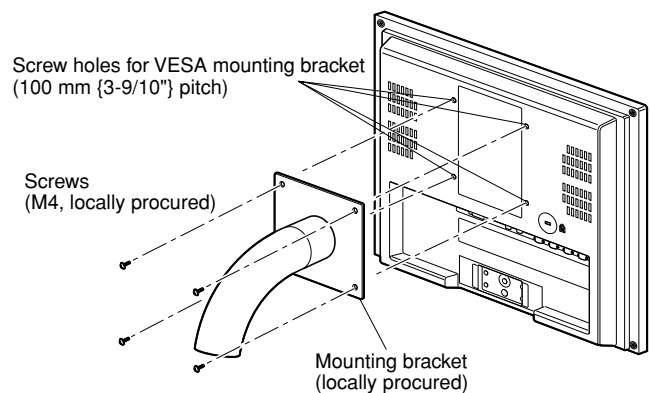

CONNECTIONS

■ Connection Example

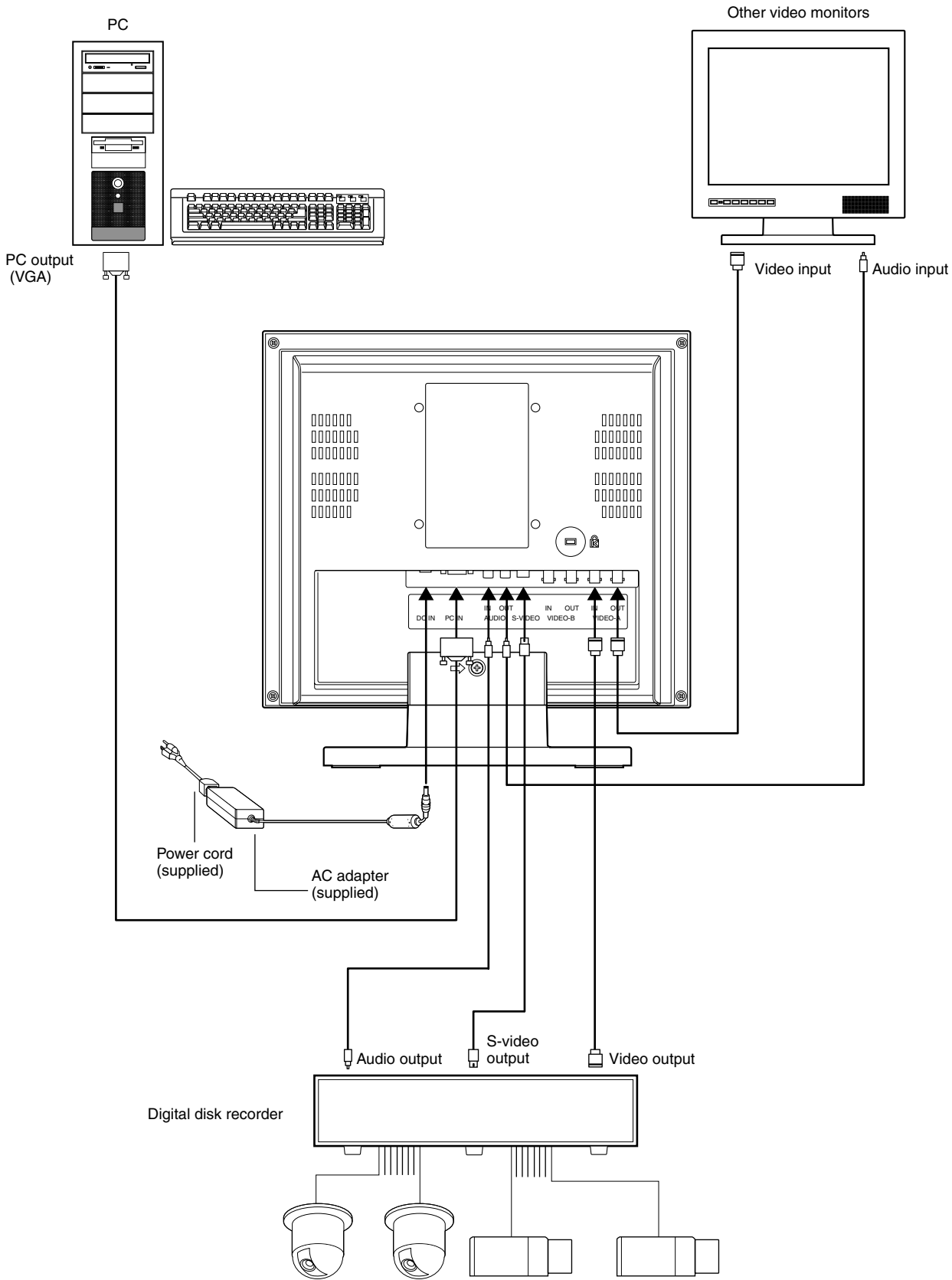

■ Camera Connection

Connect the video output connector of camera to the VIDEO IN connector with a coaxial cable.

Note: Make sure that the cable length between the camera and monitor is as follows.

Cable type	Cable length
RG-59/U 3C-2V	250 m {820 ft.}
RG-6/U 5C-2V	500 m {1 640 ft.}
RG-11/U 7C-2V	600 m {1 968 ft.}
RG-11/U 10C-2V	800 m {2 625 ft.}

■ Connection with Two or More Video Monitors

- Connect the VIDEO OUT connector of this monitor to the video input connector of another monitor with a coaxial cable.
- Connect the AUDIO OUT connector of this monitor to the audio input connector of another monitor with an audio cable.

Notes:

- Up to 10 monitors can be connected to this monitor. If 11 or more monitors are connected, picture quality may be degraded.
- Total cable length should not exceed 150 m {492 ft.}.

■ Digital Disk Recorder Connection

● To Perform Recording

- Connect the VIDEO OUT connector of this monitor to the video input connector of digital disk recorder (or other recording devices) with a coaxial cable.
- If necessary, connect the AUDIO OUT connector of the monitor to the audio input connector of digital disk recorder (or other recording devices) with an audio cable.

● To Perform Playback

Do either of the following.

- Connect the VIDEO IN connector of this monitor to the video output connector of digital disk recorder (or other recording devices) with a coaxial cable.
- Connect the S-VIDEO IN connector of this monitor to the S-video output connector of digital disk recorder (or other recording devices) with an S-video cable.

● To Output Audio Signal

Connect the AUDIO IN connector of this monitor to the audio output connector of digital disk recorder (or other recording devices) with an audio cable.

■ PC Connection

Connect the PC IN connector of this monitor to the analog RGB output connector of PC (or another device).

POWER-ON

Before operation, check the connections between monitors and external devices (cameras, digital disk recorders, etc.) (Refer to p. 11.)

1. Press the power button. The monitor will be powered on, and the power indicator will light up in green.
2. Press the INPUT SELECT button.
Every pressing this button can change input signals as follows.

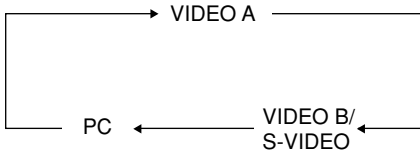

The signal name will be displayed on the upper right corner of screen for 3 seconds.

Signal name	Input signal type
VIDEO A	Composite video A
VIDEO B	Composite video B
S-VIDEO	S-video
PC	PC (Analog RGB)

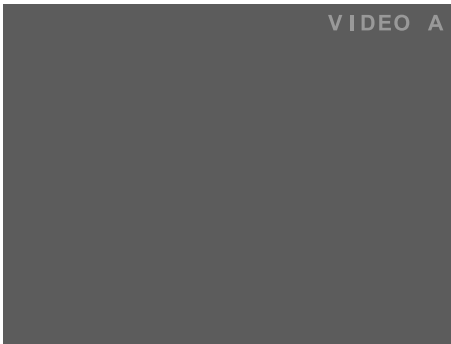

Notes:

- When no input signal is supplied to the monitor, "NO SIGNAL" will be displayed on the screen. "NO SIGNAL" will continue to be displayed until an input signal is supplied.



- When the loss of input signal is detected due to cable disconnection, etc., "VIDEO LOSS" will be displayed on the screen. "VIDEO LOSS" will continue to be displayed until a cable is connected.

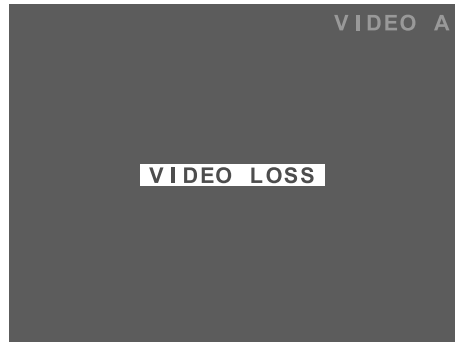

- When the PC input signal is selected and picture display position is not proper, perform the VGA output setting for the connected PC.

AUDIO VOLUME CONTROL

By pressing the + or – button during picture display, you can adjust the audio volume level. While the + or – button is pressed, the volume level is displayed on the screen.

- : Audio volume level goes down.
- +: Audio volume level goes up.

Setting item	Effect	Setting value
AUDIO	+: Audio volume level goes up. -: Audio volume level goes down.	0 to + 40

VIDEO ADJUSTMENT AND SETUP

■ VIDEO ADJUST Menu

Setup of this monitor will be performed in the VIDEO ADJUST menu.

Notes:

- The menu title display differs depending on the selected input signal. Before adjustment, press the INPUT SELECT button surely to select the input signal. (Refer to p. 13.)
- If the power is shut down during setup, the setting values will not be saved.

1. Press the MENU button. The top menu will be displayed.

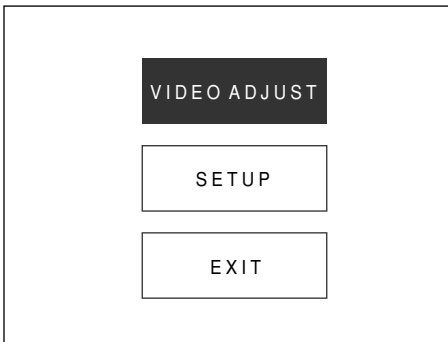

2. Move the cursor to VIDEO ADJUST by pressing the ▼ or ▲ button. Then, press the MENU button.

- While the VIDEO A, VIDEO B, or S-VIDEO input signal is currently being selected, the following menu will be displayed.

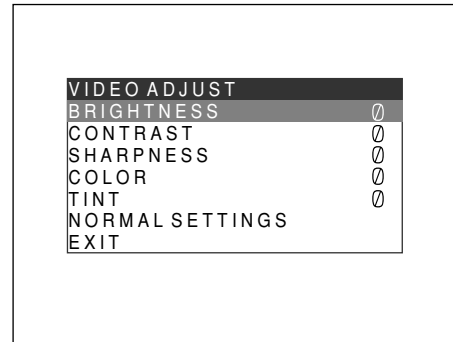

- While the PC input signal is currently being selected, the following menu will be displayed.

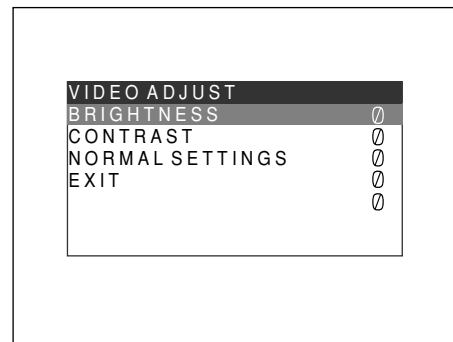

3 Move the cursor to the following setting items by pressing the ▼ or ▲ button. Then, adjust the levels by pressing the + or – button.

Setting item	Effect	Setting value
BRIGHTNESS	+ : Brightness level goes up. – : Brightness level goes down.	– 20 to + 20
CONTRAST	+ : Contrast level goes up. – : Contrast level goes down.	– 20 to + 20
SHARPNESS	+ : Picture quality becomes sharper. – : Picture quality becomes softer.	– 15 to + 15
COLOR	+ : Color density level goes up. – : Color density level goes down.	– 20 to + 20
TINT (NTSC system only)	+ : Tint becomes more reddish. – : Tint becomes more greenish.	– 20 to + 20

Note: Value can be set differently for each input signal.

- To reset the settings, move the cursor to NORMAL SETTINGS by pressing the ▼ or ▲ button. Then, press MENU button. The setting items of input signal currently selected will be reset to the factory default.
- To return to the top menu, move the cursor to EXIT by pressing the ▼ or ▲ button. Then, press the MENU button.
- After returning to the top menu, move the cursor to EXIT by pressing the ▼ or ▲ button. Then, press the MENU button. The monitor display return to the default status.
Note: If no operation has been performed for 10 seconds or more, the monitor display returns to the default status.

■ Setting of PC Input

While the PC input signal is being selected, you can adjust the horizontal position and vertical position.

Note: If the power is shut down during setup, the setting values will not be saved.

- Press the MENU button. The top menu will be displayed.

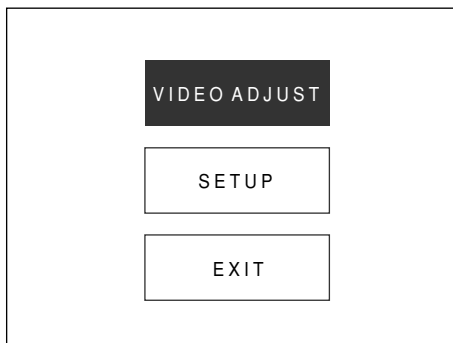

- Move the cursor to SETUP by pressing the ▼ or ▲ button. Then, press the MENU button. The SETUP menu will be displayed.

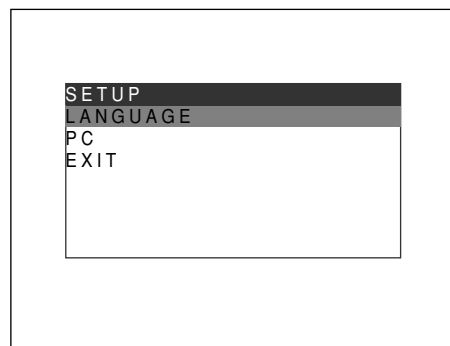

- Move the cursor to PC by pressing the ▼ or ▲ button. Then, press the MENU button. The PC menu will be displayed.

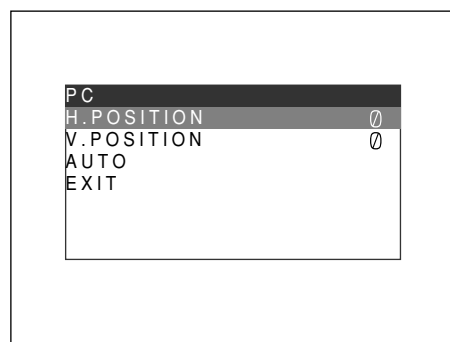

4. Move the cursor to AUTO by pressing the ▼ or ▲ button. Then, press the MENU button. The picture display position will be adjusted automatically.

Manual adjustment

If picture display position is not properly adjusted, move the cursor to the desired setting item by pressing the ▼ or ▲ button. Then, adjust the levels by pressing the + or – button.

Setting item	Effect	Setting value
H.POSITION	+ : Moves rightward. – : Moves leftward.	– 20 to + 20
V.POSITION	+ : Moves upward. – : Moves downward.	– 20 to + 20

5. To return to the top menu, move the cursor to EXIT by pressing the ▼ or ▲ button. Then, press the MENU button.
6. After returning to the top menu, move the cursor to EXIT by pressing the ▼ or ▲ button. Then, press the MENU button. The monitor display return to the default status.

Notes:

- If no operation has been performed for 10 seconds or more, the monitor display returns to the default status.
- Check if the VGA output setting has been performed for the connected PC.
- Depending on the connected PC, the VIDEO ADJUST menu can be controlled from the PC keyboard. However, proper adjustment is not supported.

When connecting Digital Disk Recorder WJ-HD300 Series

When the PC IN of this monitor is connected to the MONITOR (VGA) of Digital Disk Recorder WJ-HD300 Series, picture display position may not be properly adjusted even after you perform auto adjustment. In this case, perform "Manual adjustment" in Step 4.

■ Language Setup

You can select the language for monitor display.

Note: If the power is shut down during setup, the setting values will not be saved.

1. Press the MENU button. The top menu will be displayed.

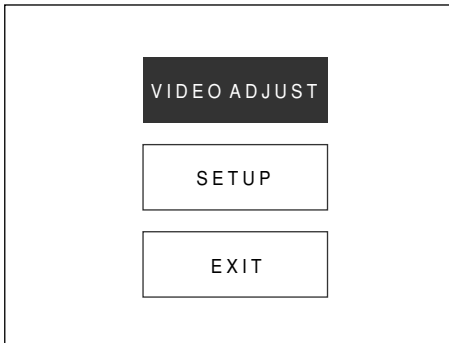

2. Move the cursor to SETUP by pressing the ▼ or ▲ button. Then, press the MENU button. The SETUP menu will be displayed.

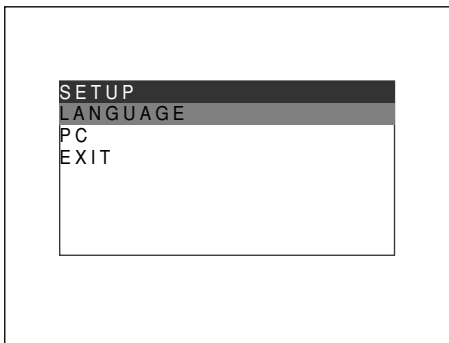

3. Move the cursor to LANGUAGE by pressing the ▼ or ▲ button. Then, press the MENU button. The LANGUAGE menu will be displayed.

4. Move the cursor to the desired language by pressing the ▼ or ▲ button. Then, press the MENU button. The selected language will be applied for monitor display.



5. To return to the top menu, move the cursor to EXIT by pressing the ▼ or ▲ button. Then, press the MENU button.

6. After returning to the top menu, move the cursor to EXIT by pressing the ▼ or ▲ button. Then, press the MENU button.

The monitor display return to the default status.

Note: If no operation has been performed for 10 seconds or more, the monitor display returns to the default status.

TROUBLESHOOTING

Check the following before requesting repair.

If a trouble cannot be corrected even after checking and trying remedy, contact your dealer.

Symptom	Cause/solution	Reference pages
Power is not turned on.	▶ Check if the power plug is properly connected to the AC outlet.	—
	▶ Check if the DC plug of AC adapter is properly inserted into the DC IN jack of this monitor.	—
	▶ Check if the power cord is properly inserted into the AC adapter.	—
"NO SIGNAL" appears on the screen, and no picture is displayed.	▶ Check the cables are properly inserted into the connectors.	11, 13
	▶ Check if the cable connection is corresponding with the selected input signal.	11, 13
"OUT OF RANGE" appears on the screen, and no picture is displayed.	▶ When the PC input signal does not meet the standards of this monitor, no picture is displayed. Check the specifications of connected PC.	9, 15
Picture display position is not proper while the PC input signal is being selected.	▶ Perform auto adjustment on the PC menu. If the picture display position is not properly adjusted, perform manual adjustment.	15
The power cord insulation is damaged.	▶ The power cord, plug and connectors are worn out. If you continue to use it, a fire or an electric shock may occur. Unplug the AC adapter immediately, and refer servicing to qualified service personnel.	—
The power cord, plug and connectors get hot during use.		
The power cord gets hot when bent or stretched.		

SPECIFICATIONS

■ Video Monitor

Power Source:	12 V DC, 4.58 A (using the supplied AC adapter)
Power Consumption:	WV-LD2000: 51 W (including the supplied AC adapter) WV-LD1500: 43 W (including the supplied AC adapter)
Display Panel:	WV-LD2000: 20" TFT LCD, Built-in dual CCFT's WV-LD1500: 15" TFT LCD, Built-in dual CCFT's
Display Area:	WV-LD2000: 408 mm (H) x 306 mm (V) {16" (H) x 12" (V)} WV-LD1500: 305.28 mm (H) x 228.96 mm (V) {12" (H) x 9" (V)}
Resolution:	640 x 480 (VGA)
Aspect Ratio:	4 : 3
Brightness:	400 cd/m ² (Typical)
Contrast Ratio:	WV-LD2000: 500 : 1 (Typical)* WV-LD1500: 800 : 1(Typical)*
Display Colors:	Approx. 16 000 000
Viewing Angle (L-R/U-D):	WV-LD2000: 160°/140°* WV-LD1500: 176°/176°*
TV Mode:	Composite Video Input / Y/C Video Input: NTSC/PAL (Auto)
Horizontal Resolution:	450 or more TV lines
Video Input (VIDEO-A IN, VIDEO-B IN):	1.0 V [P-P]/75 Ω (BNC), composite video signal
Video Output (VIDEO-A OUT, VIDEO-B OUT):	Auto-termination loop-thru (BNC)
S-video Input (S-VIDEO IN):	Y=1.0 V [P-P]/75 Ω, C= 0.3 V [P-P]/75 Ω, Mini DIN jack
PC Input (PC IN):	RGB, 0.7 V [P-P]/75 Ω, Horizontal and vertical timing pulse: TTL, 15-pin Mini D-sub connector
Speaker Output:	1.5 W
Audio Input:	-8 dB/Hi-Z, RCA pin jack
Audio Output:	Loop-thru output, RCA pin jack
Ambient Operating Temperature:	0 °C to +40 °C {+32 °F to +104 °F}
Ambient Storage Temperature:	-20 °C to +65 °C {-14 °F to +149 °F}
Ambient Operating Humidity:	Less than 90 %
Screw holes for VESA mounting bracket:	100 mm {3-9/10"} pitch, VESA standard
Dimensions:	WV-LD2000: 490 mm (W) x 453 mm (H) x 236 mm (D) {19-1/3" (W) x 17-4/5" (H) x 9-3/10" (D)} (including the monitor stand) 490 mm (W) x 403 mm (H) x 86 mm (D) {19-1/3" (W) x 15-9/10" (H) x 3-2/5" (D)} (excluding the monitor stand) WV-LD1500: 370 mm (W) x 375 mm (H) x 236 mm (D) {14-2/5" (W) x 14-4/5" (H) x 9-3/10" (D)} (including the monitor stand) 370 mm (W) x 325 mm (H) x 86 mm (D) {14-2/5" (W) x 12-4/5" (H) x 3-2/5" (D)} (excluding the monitor stand)
Weight:	WV-LD2000: 8.89 kg {2.0 lbs.} (including the monitor stand) 7.64 kg {16.8 lbs.} (excluding the monitor stand) WV-LD1500: 5.12 kg {11.3 lbs.} (including the monitor stand) 3.87 kg {8.5 lbs.} (excluding the monitor stand)

* Factory default

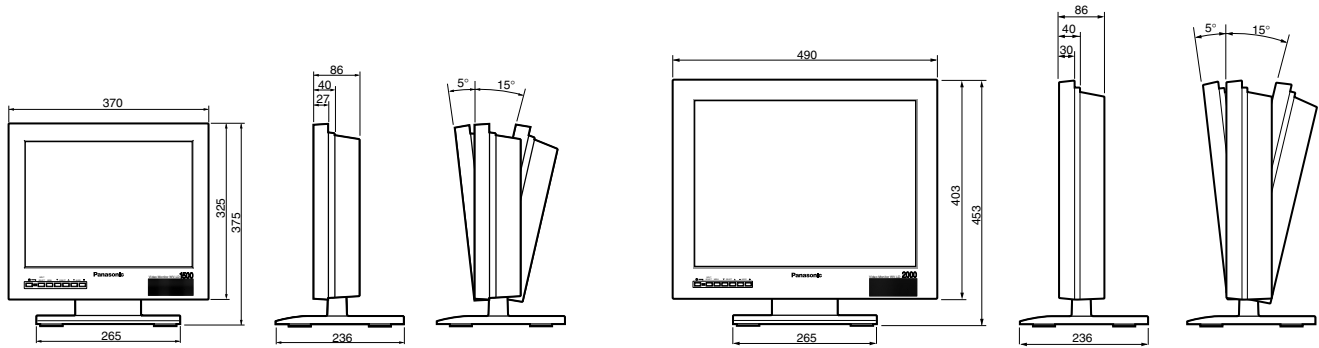

WV-LD1500

WV-LD2000

(Unit: mm)

■ AC Adapter

Power Source:	100 V AC to 240 V AC, 50/60 Hz
Output voltage:	12 V DC
Output current capacity:	4.58 A
Dimensions:	120 mm (W) x 60 mm (H) x 35 mm (D) {4-7/10" (W) x 2-2/5" (H) x 1-2/5" (D)} (excluding the DC cable)
Weight:	0.35 kg {0.77 lbs.}

STANDARD ACCESSORIES

Operating Instructions (This Document)	1 pc.
AC Adapter (Cable length: 1.8 m {6'})	1 pc.
Power Cord (1.8 m {6'})	1 pc.
Warranty Card	1 pc.

Panasonic System Solutions Company,
Unit Company of Panasonic Corporation of North America

Security Systems

www.panasonic.com/security

For customer support, call 1.877.733.3689

Executive Office: Three Panasonic Way 2H-2, Secaucus, New Jersey 07094

Zone Office

Eastern: Three Panasonic Way, Secaucus, New Jersey 07094

Central: 1707 N. Randal Road, Elgin, IL 60123

Southern: 1225 Northbrook Parkway, Suwanee, GA 30024

Western: 6550 Katella Ave., Cypress, CA 90630

Panasonic Canada Inc.

5770 Ambler Drive, Mississauga,
Ontario, L4W 2T3 Canada (905)624-5010
<http://www.panasonic.ca>

Panasonic Sales Company

Division of Panasonic Puerto Rico Inc.
San Gabriel Industrial Park 65th Infantry Ave. KM. 9.5 Carolina
P.R. 00985(809)750-4300